

# Modeling receiver noise performance using simulated hot-cold load measurements

Yebes IT-CDT-2022-01

**Authors:** Ricardo I. Amils, Inmaculada Malo, Juan Daniel Gallego, Isaac López-Fernández, Carmen Díez, Oscar García



Observatorio de Yebes  
Apartado 148  
19080 Guadalajara  
SPAIN

**Date:** 2022-04-04

**Revision:** A



## CHANGE RECORD

Date/version	Affected Section(s)	Change / Reason / Remark
A	All	First Issue

## TABLE OF CONTENTS

I.	Abstract .....	3
II.	Introduction .....	3
III.	Method demonstration .....	4
IV.	Cryogenic receiver simulation .....	5
V.	Comparison to cryogenic receiver noise measurements .....	8
VI.	Conclusions .....	9

## I. Abstract

Noise contributions due to mismatch between stages in cryogenic radio astronomy receivers may be significant and not easily taken into account. The need to model these effects in receivers using linear polarizers and 90° hybrids to obtain circular polarizations is complex because it leads to a system where several noisy inputs contribute to a single output. In this report we propose a method to model such cases based on mimicking hot-cold load Y-factor noise measurements using Keysight Advanced Design System (ADS) software. The method is tested on a simplified system and then used to model the noise contribution of a portion of a real cryogenic radio astronomy C-X band receiver.

## II. Introduction

A method is described to calculate the noise contribution at an output of a radio frequency circuit when signal is provided simultaneously by two or more inputs, using Keysight Advanced Design System (ADS) software. The use of the traditional noise modeling approach in ADS, using *S-Parameter mode*, does not allow directly simulating this as it requires the definition of a single input. The proposed solution approaches the problem from a different perspective by modeling the noise contribution from the total noise power at the desired output terminal in *AC mode* using the Y-factor method.

This method has been used in the CX-band receiver depicted in figure 1 to simulate the noise contribution of the LNAs and the 90° hybrid, when the latter is loaded with the measured return loss of the OMT output ports (including feed and vacuum window). For simplicity, the coaxial lines (depicted in green and blue in figure 1) as well as reference signal injection couplers have not been considered.

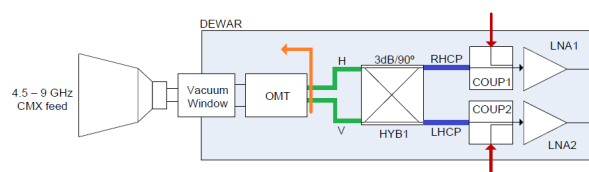

Figure 1. CX-band receiver used in this report. The orange arrow depicts the reference plane of the return loss at the OMT output ports.

The following notes apply throughout this document:

- Two circuits are used to model the hot-cold load measurements in a single simulation run, one where the temperature of the input loads are set to  $T_{hot}$  (300 K) and another where they are set to  $T_{cold}$  (77 K).
- For simplicity, in the noise model of the receiver, only one of the outputs is evaluated.

- Ideal, lossless, 1000 mm transmission lines are used throughout this report in order to simulate a standing wave periodicity similar to the one that appears in the experimental noise measurements of the receiver (see figure 16).
- The hot-cold load noise analysis that is being performed requires an *AC Simulation Controller* where certain voltage nodes are defined (*NoiseNodes*) and later used to calculate noise and gain using the Y-factor method. These nodes are inserted as wire labels at the output loads of the simulated circuits. In order to avoid erratic points in the lower part of the band of the noise and gain results, an *S-Parameter Simulation Controller* must be inserted in the simulation (the reason for this is not fully understood).
- Simulation ambient temperature throughout this report is set to 15 K.

### III. Method demonstration

The validity of the proposed method is demonstrated by comparing its results for a cryogenic standalone amplifier (loaded with 50 Ohms) to those that are obtained using a common ADS noise modeling technique (by means of a *S-Parameter Simulation Controller*). The two required circuits for this simulation, one in which the load impedance is set to  $T_{hot}$  and another where is set to  $T_{cold}$ , appear in figure 2 (the required noise nodes are  $V_{loadLNA\_hot}$  and  $V_{loadLNA\_cold}$ ).

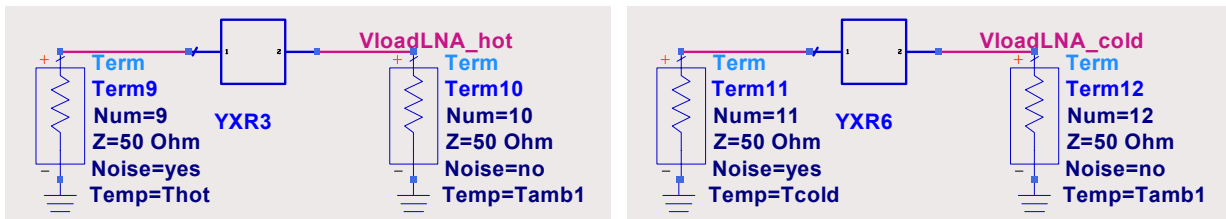

Figure 2. Circuit used to model the noise contribution of a standalone LNA.

Figure 3 details the simulation controllers and variables required in order to run the simulation.

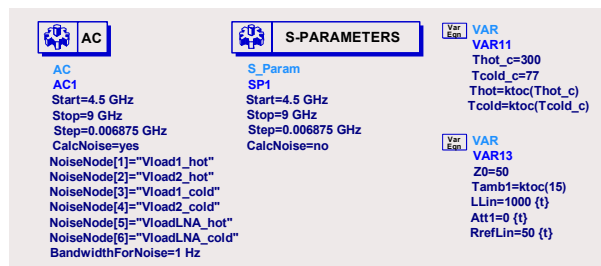

Figure 3. Simulation controllers and variables used in this report.

After simulation, noise and gain are computed by the Y-factor method using following equations:

$$\begin{aligned}
 T_{cold} &= 77 \\
 T_{hot} &= 300 \\
 R &= 50 \\
 Y &= ((V_{loadLNA\_hot}.noise)**2) / ((V_{loadLNA\_cold}.noise)**2) \\
 T_N &= (T_{hot} - Y * T_{cold}) / (Y - 1) \\
 P_{hot} &= (V_{loadLNA\_hot}.noise**2) / R
 \end{aligned}$$

$$P_{cold} = (V_{loadLNA\_cold.noise} ** 2) / R$$

$$G = (P_{hot} - P_{cold}) / (1 * boltzmann * (T_{hot} - T_{cold}))$$

Results for the standalone amplifier in figure 2 are depicted in figures 4 and 5 (blue) together with the results obtained using the traditional ADS noise analysis method (red). The results of the two methods are compared in figure 6.

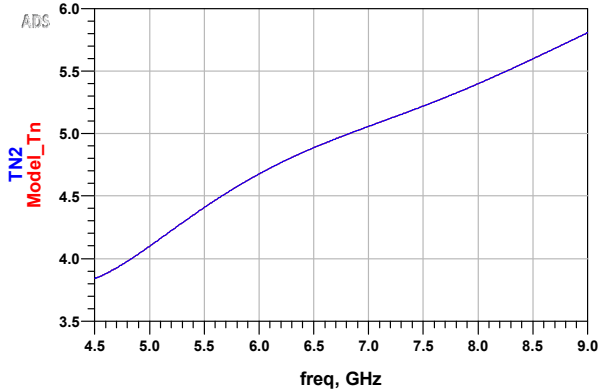

Figure 4. Noise result using the proposed method on the circuit in figure 2 (blue) compared to the traditional ADS noise analysis method (red).

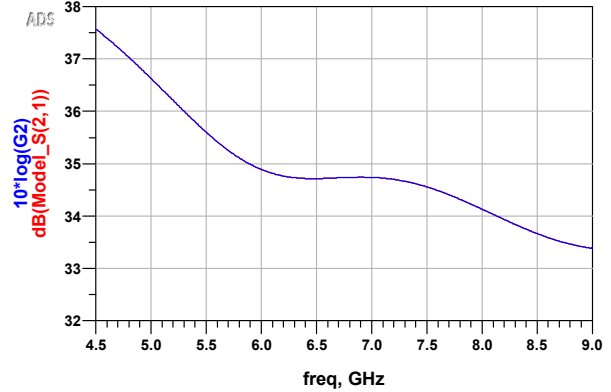

Figure 5. Gain result using the proposed method on the circuit in figure 2 (blue) compared to the traditional ADS noise analysis method (red).

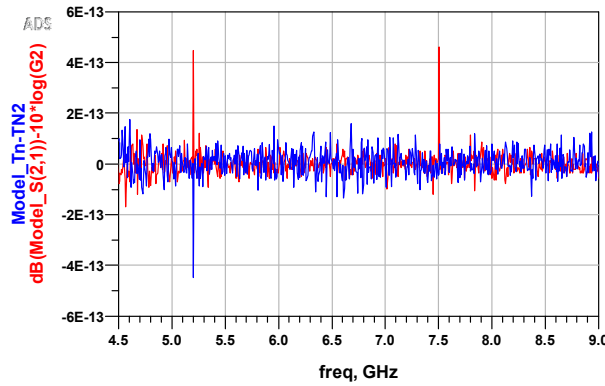

Figure 6. Comparison of results between proposed and traditional ADS methods for noise (blue) and gain (red).

## IV. Cryogenic receiver simulation

The proposed noise modeling method is applied to evaluate the noise contribution at one of the outputs of the receiver depicted in figure 1 produced by the mismatch of the two outputs of the OMT. In order to do so, a 300 K temperature, 2 port S-Parameter measurement at the two outputs of the OMT (loaded with Vacuum Window and Feed) is used. The S11 and S22 values of this measurement, transformed to impedances (figure 7), are presented as the loads for the inputs of a 4 port module containing the cryogenic S-Parameter measured results of the 3dB 90° hybrid. The purpose of this hybrid is to transform the linear polarization coming out of the OMT into circular polarization. The circuit used to model the receiver is depicted in figure 8 (for simplicity, only the circuit with  $T_{hot}$  temperature values is depicted, the required

noise nodes are Vload1\_hot and Vload2\_cold). The same simulation controllers and variables used for the standalone LNA (figure 3) are used in this case.

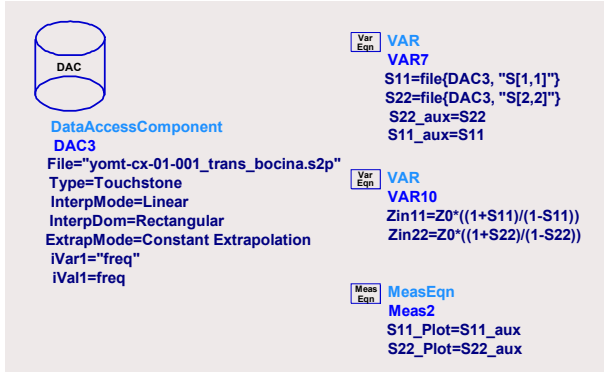

Figure 7. Data incorporation of the OMT S-Parameter measurements used as inputs in the circuit in figure 8.

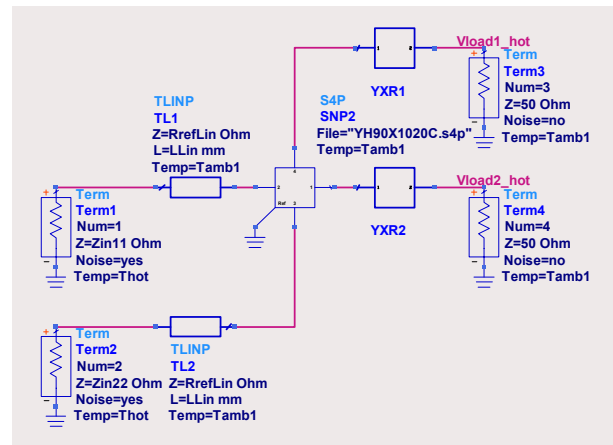

Figure 8. Circuit used to model the noise contribution of the considered portion of the receiver. Only Thot temperature value is depicted.

In order to further understand the circuit that is being modeled, figure 9 plots the impedance that is presented at the input of each one of the amplifiers (red and blue). For comparison, figure 9 also includes the impedances presented by the OMT (loaded with Vacuum Window and Feed) at the input of the hybrid (pink and green). It can be seen that the hybrid improves the adaptation of the signal by approximately 10 dB.

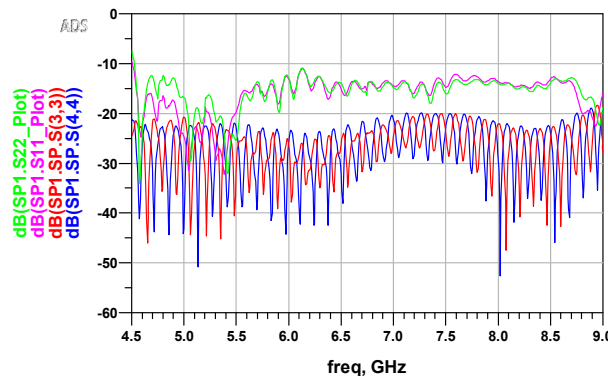

Figure 9. Impedances presented at the input of each one of the amplifiers (red and blue) and impedances presented by the OMT at the input of the hybrid (pink and green).

The same simulation controllers and variables used for the standalone LNA (figure 3) are used in this case. Noise and gain are computed using the same equations as in the case of the standalone LNA. The modeled noise and gain results are depicted in figures 10 and 11 (blue) together with the results obtained for the standalone LNA (red).

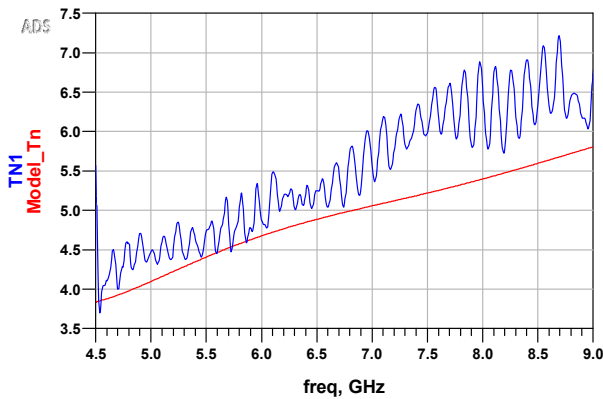

Figure 10. Noise result using the proposed method on the circuit in figure 8 (blue) compared to the 50 ohm loaded standalone amplifier (red).

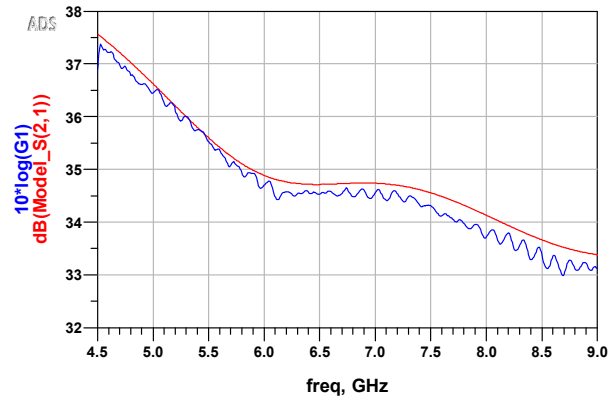

Figure 11. Gain result using the proposed method on the circuit in figure 8 (blue) compared to the 50 ohm loaded standalone amplifier (red).

In order to evaluate the essential role played by the hybrid, figures 13 and 14 depict the results that would be obtained (blue) if the linearly polarized output signals from the OMT (loaded with Vacuum Window and Feed) were directly amplified by the LNA as depicted by the circuit in figure 12 (for simplicity, only the circuit with  $T_{hot}$  temperature values is depicted, the required noise nodes are  $V_{loadLNA\_hot}$  and  $V_{loadLNA\_cold}$ ). The same simulation controllers and variables used for the standalone LNA (figure 3) are used in this case. Figures 13 and 14 also include the results for the standalone LNA (red).

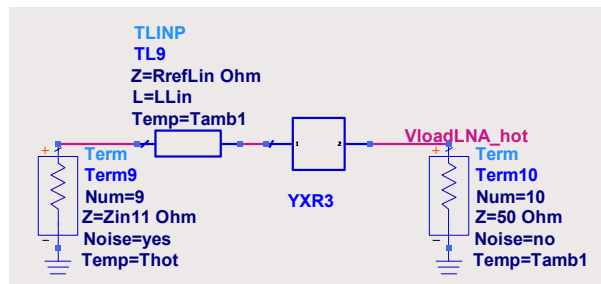

Figure 12. Circuit used to model the noise contribution if the hybrid was eliminated from the receiver. Only  $T_{hot}$  temperature value is depicted.

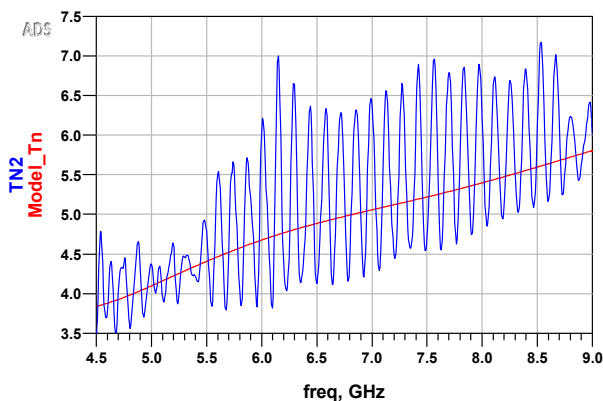

Figure 13. Noise result using the proposed method on the circuit in figure 12 (blue) compared to the 50 ohm loaded standalone amplifier (red).

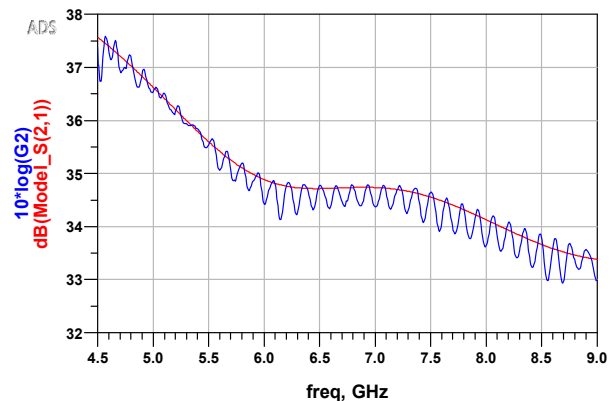

Figure 14. Gain result using the proposed method on the circuit in figure 12 (blue) compared to the 50 ohm loaded standalone amplifier (red).

Noise ripple results clearly deteriorate as a consequence of the elimination the hybrid in the receiver.

## V. Comparison to cryogenic receiver noise measurements

The proposed method is used to fit a set of measured data of a working CX-band receiver as the one depicted in figure 1. The following strategies have been used to account for additional noise level and ripple amplitude:

- Additional average noise levels observed in the experimental results are attributed to dissipative losses in stages in front of the hybrid that have not been taken into account in the model. These losses are simulated by inserting an attenuator in the circuit in figure 15 using the *Att1* parameter.
- Similarly, excess experimental noise ripple amplitude present in the experimental data cannot be justified by the mismatch at the OMT output ports. This contribution has been taken into account by insertion of a mismatch in the transmission line in the circuit in figure 15 using the *RrefLin* parameter.

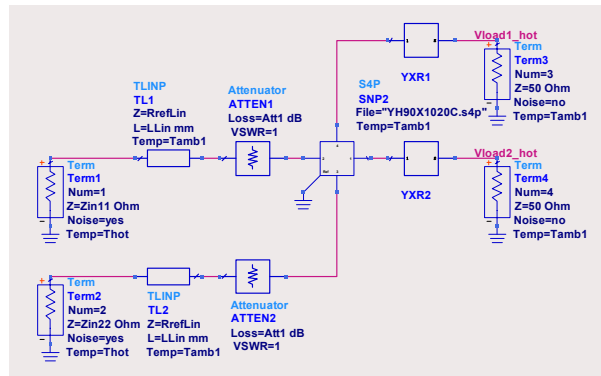

Figure 15. Circuit used to fit the noise contribution if of the receiver. Only *Thot* temperature value is depicted.

The modeled results that appear in figures 16 and 17 (blue) have been obtained with an attenuation of 1.3 dB and line reference impedance of 27 ohm and are compared with standalone LNA results (red). The same simulation controllers and variables used for the standalone LNA (figure 3) are used in this case. Figure 16 includes experimental noise measurements of the receiver (pink and green for left and right circular polarizations).

Average noise level, maximum excursion and ripple period of the measured values are adequately reproduced by the model. Ripple envelope does not follow measured results due to mismatch effects in parts of the receiver that have not been taken into account in the model. To further understand the individual contributions of the proposed attenuation and line reference impedance, figures 18 and 19 plot their contributions separately.



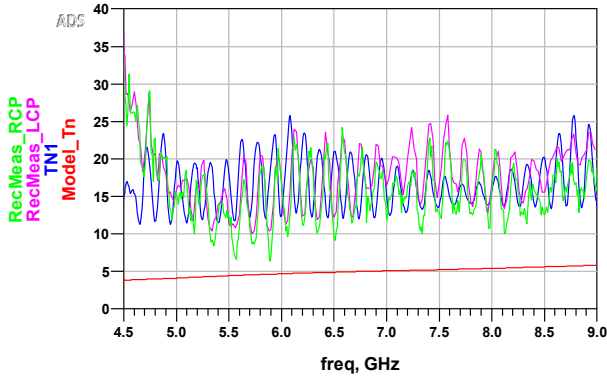

Figure 16. Noise result using the proposed method on the circuit in figure 15 (blue) with parameters  $Att1$  of 1.3 dB and  $RrefLin$  of 27 ohm compared the experimental noise measurements of the receiver (pink and green for left and right circular polarizations). The result for the 50 ohm loaded standalone amplifier is also included (red).

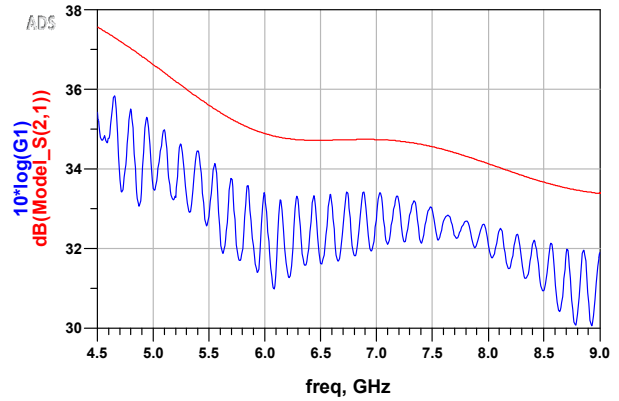

Figure 17. Gain result using the proposed method on the circuit in figure 15 (blue) with parameters  $Att1$  of 1.3 dB and  $RrefLin$  of 27 ohm compared to the 50 ohm loaded standalone amplifier (red).

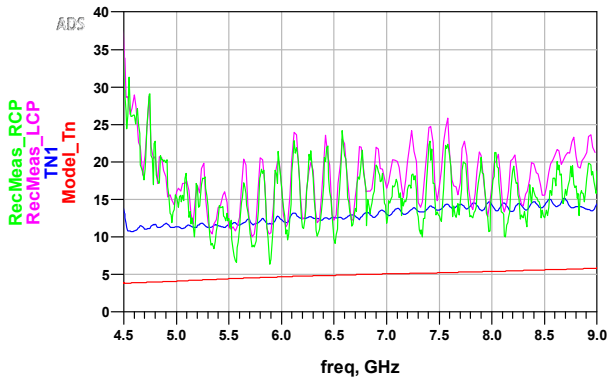

Figure 18. Noise result using the proposed method only taking into account the attenuation in the circuit in figure 15 ( $Att1$  of 1.3 dB and  $RrefLin$  of 50 ohm, blue) compared the experimental noise measurements of the receiver (pink and green for left and right circular polarizations). The result for the 50 ohm loaded standalone amplifier is also included (red).

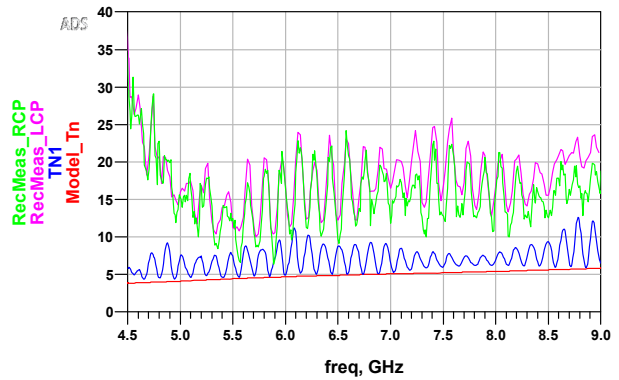

Figure 19. Noise result using the proposed method only taking into account the mismatch in the circuit in figure 15 ( $RrefLin$  of 27 ohm and  $Att1$  of 0 dB, blue) compared the experimental noise measurements of the receiver (pink and green for left and right circular polarizations). The result for the 50 ohm loaded standalone amplifier is also included (red).

## VI. Conclusions

A method to calculate the noise and gain of an amplifier using ADS software by emulating a real Y-factor measurement is presented. This method overcomes the limitations imposed by ADS software over noise calculations when *S-Parameter mode* is used, allowing, for example, to have more than one input signal or to modify the hot and cold loads presented at the input of an amplifier during the simulated measurement process.

The method has been applied to a CX-band receiver in order to try to understand the discrepancies between modeled and experimental results. It has been found that the OMT mismatch introduced in the model cannot explain the excess ripple in the measured noise performance of the receiver. Also, a non



negligible loss has to be introduced in the model in order to fit the experimental noise level. As an additional result, it has been found that the particular configuration of the receiver using a 90° hybrid significantly reduces the effect of the mismatch between the OMT and the LNAs (by means of its "balancing" effect).